







20 005 705

- with WAVES structure
- hole diameter 32 mm
- rosette 60 x 47 mm
- with cold marking



	Chrome	20 005 705-00
	Brushed Platinum	20 005 705-06
	Dark Chrome	20 005 705-19
	Brushed Champagne (22kt Gold)	20 005 705-46
	Champagne (22kt Gold)	20 005 705-47
	Brushed Dark Platinum	20 005 705-99

20 005 705

mm [inches]

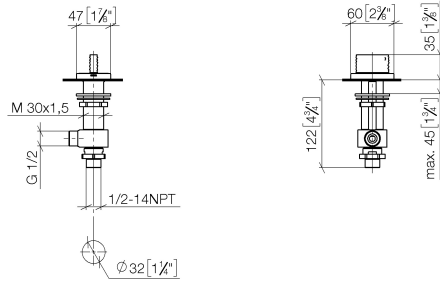

Flow rate chart



Certificates

WRAS_1804020. IAPMO_4976 (5). IAPMO_N-4976. LGA_28687. IAPMO_6397.

WRAS_240202020.

20 005 705

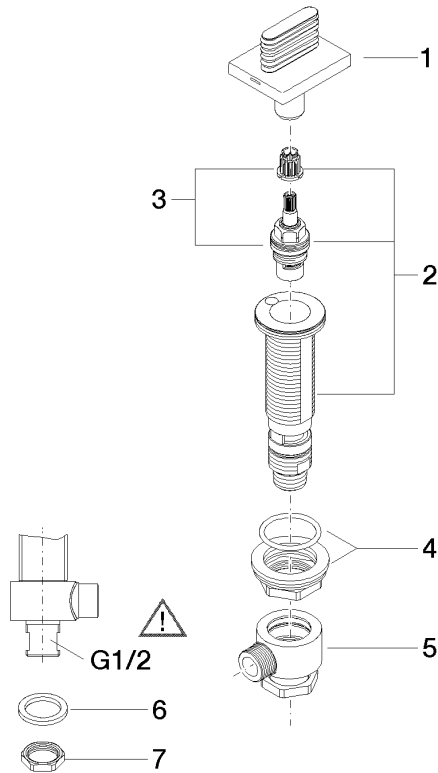

Spare parts list

No.	Item Number	Name	Quantity used	Delivery time
1	90 20 70 055 06-00	handle (cold)	1	10
2	04 17 11 058 53 90	side panel	1	2
3	90 90 03 153 00 90	top	1	2
4	04 23 10 032 78 90	fixing set	1	2
5	04 17 11 023 10 90	distributor	1	2
6	90 23 30 040 00-00	threaded connector	1	10
7	09 30 11 059 90	disc	1	2
8	09 23 10 012 90	nut	1	2